

Continuous Pursuit
in Advancing of Intelligent Robots



Hangzhou Iplusrobot Technology Co., Ltd.
1st Floor, Building 8, Jinsheng Science and Technology Park, No.611,
Dongguan Road, Hangzhou, China
T. +86-15618431381
E. customer@iplusbot.com | overseas@iplusbot.com



INTELLIGENT MOBILE ROBOT

Leading Logistics Innovation for Smart Manufacturing

www.iplusbot.com



ABOUT US

Founded in July, 2016, IPLUSMOBOT is headquartered in Hangzhou with a wholly funded subsidiary in Tianjin. Since 2000, our core team has been focusing on smart recognition and control of robot, with members from leading universities such as Zhejiang University, Tsinghua University and Southeast University. We have participated in research and development of various well-known robots with international-class technologies.

The whole series products of IPLUS MOBOT are 100% self-developed, forming a full value chain of autonomous mobile robots incorporating independent core technologies, leading products and systemic solutions. Up to now, we have 134 intellectual properties which have been awarded as national innovation companies and passed ISO:9001:2015 Quality Management System (QMS) with related products having participated in the stipulation of various national standards and industrial standards .

Intelligent Factory Logistics Solutions

With AI and robot technologies empowering logistics supply chains in factories of the manufacturing industry. IPLUS MOBOT supplies logistics automation and digitization within factories, boosting companies' competitiveness and huge potential of smart operation in the manufacturing industry. Smart factory logistics solutions are made up of industrial-class autonomous mobile robot fleets and related robots and logistics management software. Incorporating four advantages, namely smart logistics devices, end-to-end unmanned operation, flexible

material transportation and logistics digitization within factories, IPLUS helps factories to improve manufacturing productivity, reduce operation costs, product defect rates and cut down on energy consumption. Based on IPLUS abundant experience in large projects in systemic planning and cutting-edge technologies we have, our solutions have been put to use in several hundred leading companies like Brother, Baiyun Electric Equipment Company, CRRC Electric Vehicle, JCET Group, Wistron and ZKTeco Company.



Improve production efficiency



Reduce operation costs



Reduce product defect rates



Cut down on energy consumption

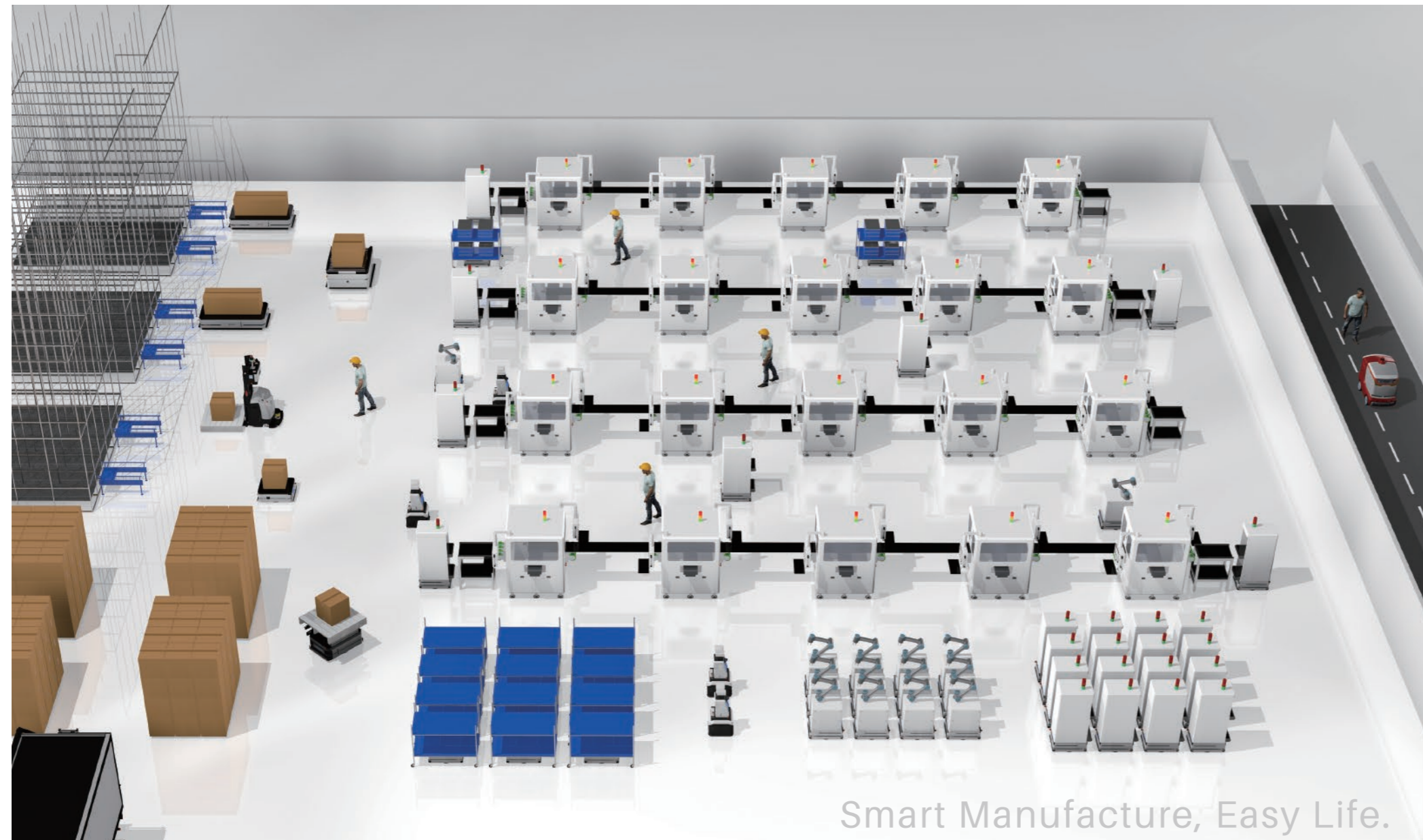

Smart logistics devices

The material transfer devices in intelligent factories use our leading-class navigation technology based on laser SLAM which has been approved by batch projects. With no need for lots of artificial markers to assist deployment, the risk of production suspension can be avoided due to damaged markers, and devices can be adjusted flexibly as needed to support operations and different paths.

Flexible transfer of materials

CLOUDIA-robot scheduling management system allows several hundred smart transfer devices to work simultaneously in intelligent factories without the limit of maximum operation capacity. CLOUDIA would automatically work out the most suitable robots based on orders to transfer, load and unload multiple kinds of materials in a flexible manner through the optimal path in various stations.

End-to-end unmanned operation

It is designed to address the tricky issue of logistic devices replacing human labor. It works with the third-party devices to dock materials perfectly when loading and unloading, it is even able to accomplish tasks simultaneously. complicated storage on devices, loading and unloading. With industry-leading robot capabilities, IPLUS has launched lots of pioneering and first leading product(s) in the industry, helping several hundred factories to realize end-to-end unmanned operation.

Logistics digitization within factories

Combining logistics management middleware software -IPLUS CLOUDIA and MCS , we can link seamlessly with logistic devices and third-party software such as WMS and MES to deal with the challenges in material-in-transit digitization.

Intelligent Factory Logistics Solutions

The solution is designed for manufacturing factories and logistics parks based on logistics requirements of various materials and processes in all kinds of industries. We offer robots and related couriers, pallets and work stations for various industries that are universally applicable with good performance in mobile operation, comprehensive safety guarantee

mechanism and quality authentication. They can achieve autonomous charging and detection with a high level of smartness. We offer efficient, flexible and safe smart robot fleets and software to help with 7*24H logistics upgrade of intelligent factories.

Easy to operate with 3 steps

The solution provides instructions on how to use autonomous mobile robot fleets through CARLY ready-to-use teaching and

programming robot software for technicians without the programming experience.

Step 1 Map

Operators only have to hold remote controllers to control mobile robots via direction buttons to move around the scene once to complete step1-creating maps for robots.



Step 2 Configure

Remote control vehicles to any working stations, logging on CARLY on computers, mobile phones or IPAD and set up automatically identified locations on Electronic maps as working stations to complete step2-set up working stations.

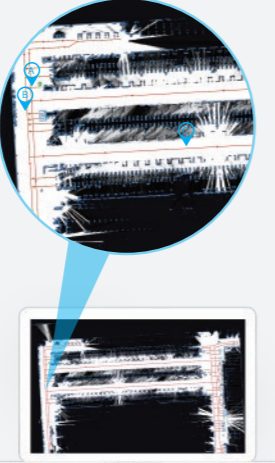

Step 3 Send tasks on-demand

Log on CARLY on computers, mobile phones or IPAD, assign, add or delete and revise tasks as required in the task editing column, press start task button upon saving tasks to complete step2-assign tasks.







Comprehensive
Logistics links indoors and outdoors all covered



Efficient
Achieve optimal scheduling and operation in all scenes



Stable
All devices have passed ISO Quality Management System (QMS)



Practical
Applicable to practical environments



Customized
Customized device forms

IPLUSMOBOT fleets ability



▶ Autonomous, simultaneous operation along the optimal routes



▶ Automatic dock charging



ATHENA
operation management system

▶ Autonomous detection and maintenance



CLOUDIA
robot scheduling and monitor platform

▶ Real time dashboard and logistic data reports

Portfolio



Platform



Transfer System



Loading And Unloading System



In-and-out Warehouse System



CLOUDIA
Fleet Management and
Control Platform



MCS
Material Control
System



WMS
Warehouse Manage-
ment System



CARLY
Customizable Action and
Robot business Logic for
deployment



ADELE
Accelerated DEvelop-
ment SDK



DARLING
Industrial Logistics Data
Analysis System



Human-robot Cooperation System



Sorting System



Patrol And Detection System



Distribution System

EMMA

Industrial-Class Mobile Robot Series



Indoor Autonomous Mobile Robot Platform

Standard AGVs for flexible material transfer, loading and unloading of 200 kg -1T material in manufacturing plants. With IPLUS fusion navigation based on laser SLAM, EMMA Standard Series are ready for large-scale, multi-floor human-machine collaborative factories. With no need for artificial markers to assist deployment, the risk of production suspension can be avoided caused by damaged markers, and devices can be adjusted flexibly according to operation and path variation.

Specification

Navigating method	Laser+Camera+IMU
Maximum payload	200kg-1000kg
Work mode	Standard chassis +customized carrier*
Work Precision	±1cm/1 ° position precision ±2mm/0.2° docking precision
Battery life	Charging Time/Running time: 2h/8h
Steering	Two-wheel differential drive, , in-place rotation is supported, omni-directional movement is supported for 1000kg-class robots

*Customized carrier: lift, back, roller, mechanical arm and customized operation unit

Advantages

Move unhindered in all scenarios

EMMA Series move freely across the factory thanks to Laser SLAM+vision+IMU fusion navigation approved by batch projects for replacing traditional mode of markers. In doing so, the risk of production suspension can be avoided caused by damaged markers. Moreover, EMMA Series enable High-Mix Low-Volume manufacturing scenarios based on flexible transportation, serving as a cornerstone of future digitized factories.



Cluster operation

EMMA Standard Series fleet+CLLOUDIA robot scheduling and management system dock systems like WMS, MES and ERP, whereby optimal coordination, and scheduling of a fleet of more than a thousand units is made possible.



Connectivity, closed-loop management

EMMA Standard Series+MCS (Material Control System) dock third-party software like WMS, MES and RCS, together with the third-party equipment like lifts, air shower doors and magnetic stripe vehicles to achieve closed-loop material management within factories.



Safe and convenient

At extremely low latency, EMMA series accomplish environmental perception and decision, multiple security mechanisms, and the operation security in the man-machine hybrid scene. With CARLY software system, it is easy to operate the robots in 3 steps.



Comprehensive and efficient

Benefitting from the ability of travelling in the whole area and the efficient collaboration with software and hardware, EMMA series ensure the turnover efficiency, reduce the quantity of robots sharply for the users, and avoid the risk of halting production at the same time.

Matching Fixtures

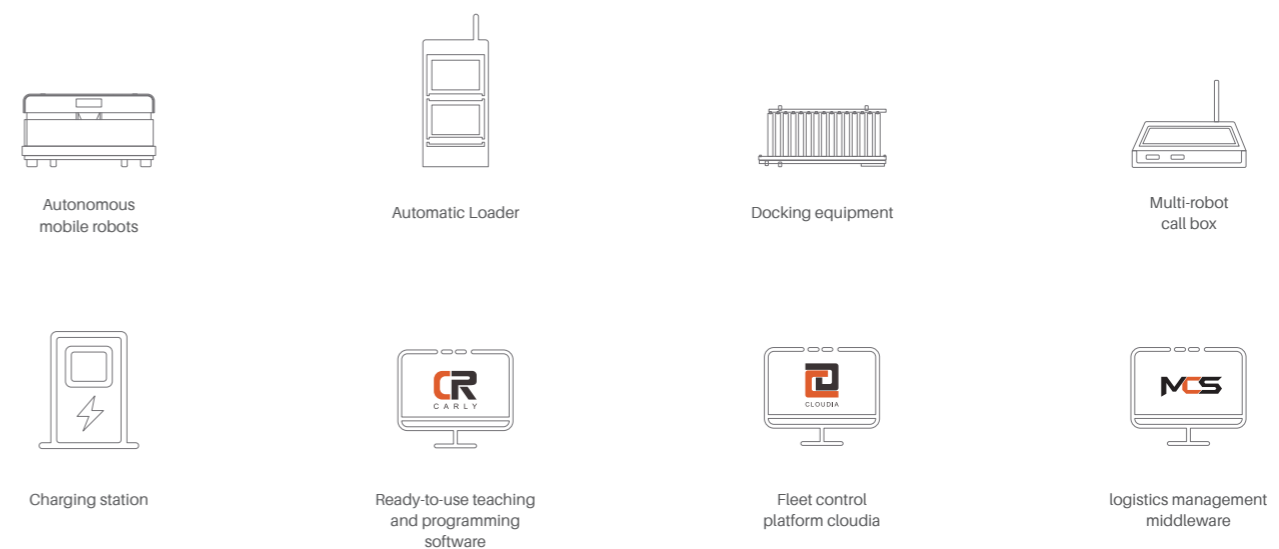

CLOUDIA

Fleet management and control platform

The powerful and elegant fleet control software Cloudia will help multiple robots work in a more efficient and collaborative way. With the advanced scheduling and planning algorithms, the system will assign different jobs to the right agent at the right time, minimize the idle time for each and every equipment of your warehouse/factory and save the overall logistics cost. Cloudia can also easily be integrated with an existing Warehouse Management System (WMS), Manufacturing Execution System (MES) or Enterprise Resource Planning (ERP) for further automation so that all the tasks and movements can be organized as a whole to gain further efficiencies.



Fleet Management System for Multiple Robots

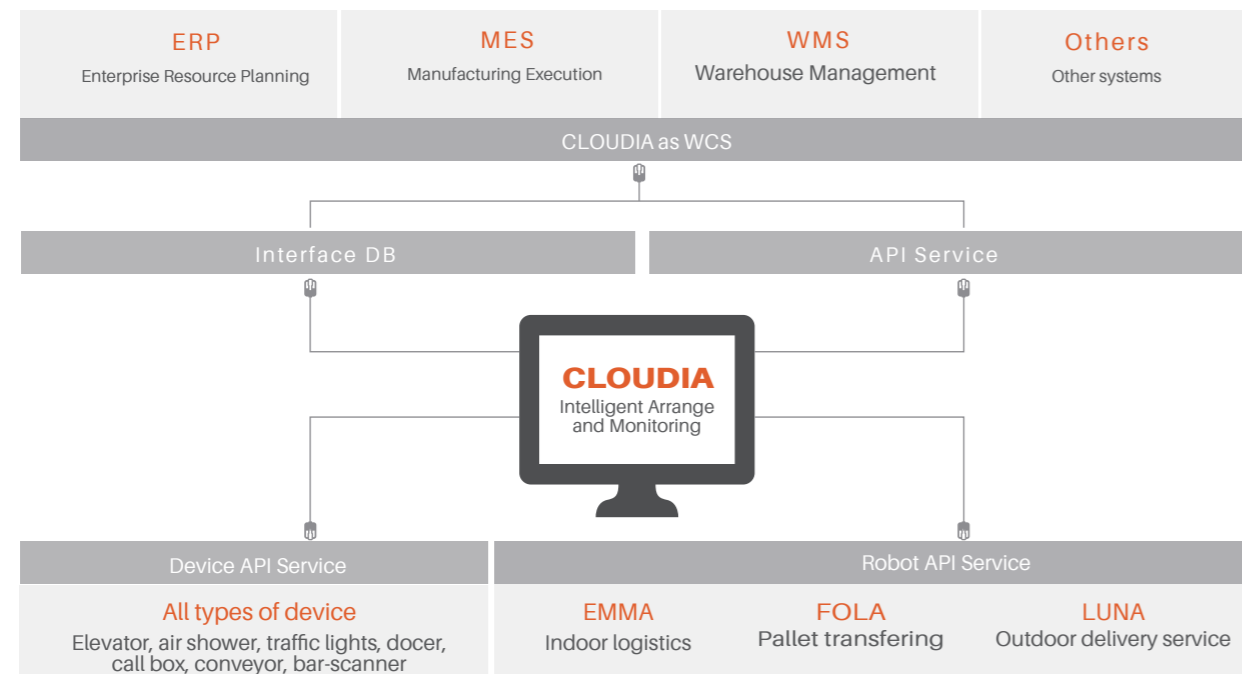

Features

- Realtime multi-robot status monitoring and tracking
- Traffic control
- Permission control
- Multiple map management
- Task management
- Malfunction and exception warning
- External device connection

MCS

Material Control System



MCS acts as the middleware between clients higher-level business system and robot fleet management system. It consists of equipment status database, material in transit information and other highly customized business logics regarding to WMS, MES, third-party equipment and AGV scheduling platform. It helps our clients connect data of manufacturing to data of logistics.

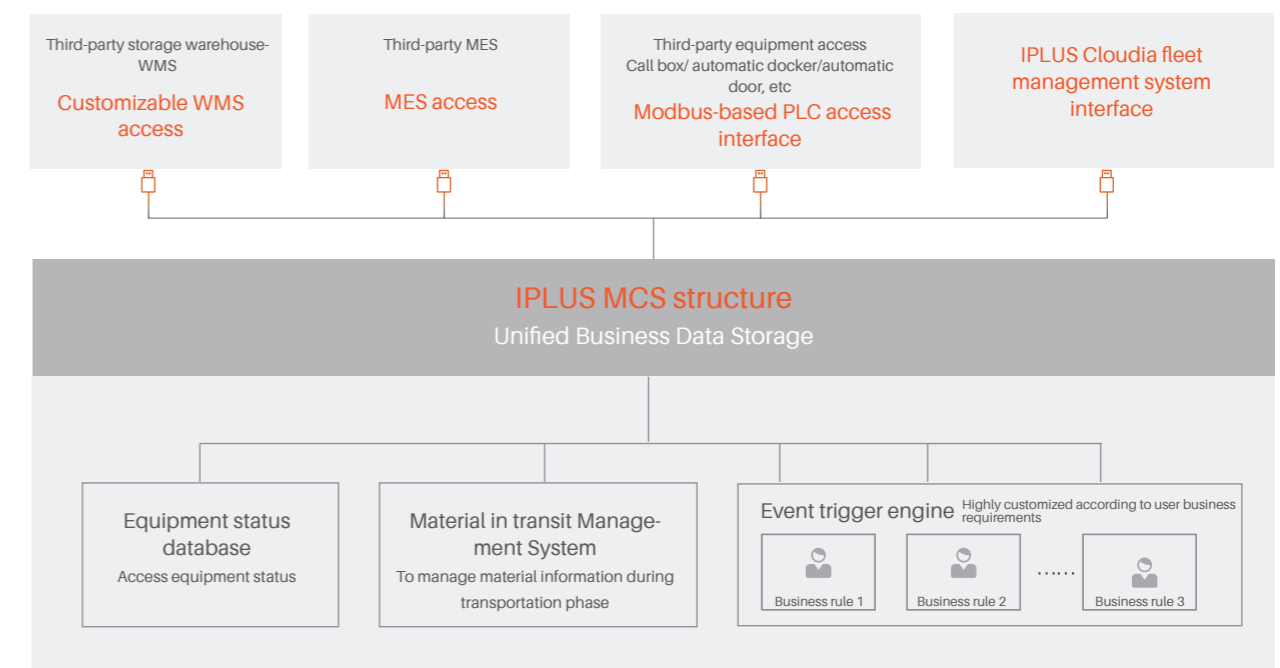

Solution



Smart Transportation of Pallets and Cargo Shelf

Raw material, process material and products can be transported seamlessly via mobile robots on shelf or pallets. With the help of our MCS and Fleet management system, the transportation between multiple warehouses and manufacture station can be easily achieved.

Autonomous Docking and Loading

Robot can dock precisely to dockers of production line and transfer cargo through conveyors. Communication between the robot and cargo is modulated by our MCS system to ensure the safety transportation of the cargo.

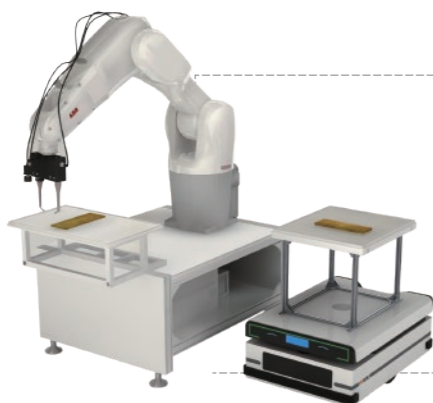
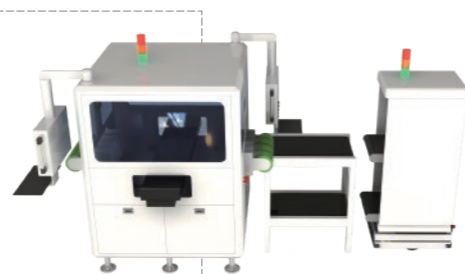

Autonomous Work Station

By connecting autonomous work station into our MCS and Cloudia, the system thus can control both the manipulator of work station and the mobile robots to realize full automation of both the manufacturing and transportation, further reducing human interference and improves efficiency.

Mobile Manipulator

Collaborative manipulator and autonomous mobile robot platform can be combined as a mobile manipulator to break the limitation of operation space.



Use Cases



Semiconductor and electronic information manufacturing



New energy and photovoltaic industry



Panel manufacturing



5G communication equipment manufacturing industry



Electricity transmission and distribution equipment manufacturing



Automobile industry



Pharmaceuticals industry



Textile industry



Heavy industry



Aerospace equipment manufacturing



Ports, gardens, airports

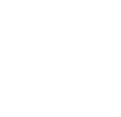

Semiconductor and electronic information manufacturing



3C Product ODM Manufacturing

Flexible transfer of materials between production lines.



Display Equipment Manufacturing

Flexible transportation of cassettes and magazines between different work stations.



Process Control Equipment Manufacturing

The very best automate material transportation solution for super High-Mix Low-Volume manufacturing scenario.

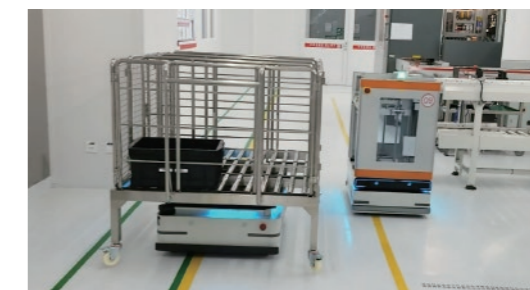

Semiconductor Packaging And Testing

Flexible transportation of cassettes and magazines between different work stations.



Consumer Electronics

AGV customized to dock existing feeder equipment, combined with call box and dispatching system, to achieve on-demand material transfer.



5G Communication Equipment Manufacturing

Mobile robots take important positions in product transportation between production line and testing line.



The intelligent transfer of axles indoor and outdoor of a famous automobile manufacturing enterprise

The intelligent transfer of axles inside and outside the plants of automobile manufacturing enterprise, seamless switching between production lines indoor and logistics transport outdoor, applicable to light rain.



Intelligent transfer of axle housing assembling process of an auto parts manufacturing enterprise

Enable the autonomous transfer of the process from the unloading to assembling of the axle housing.

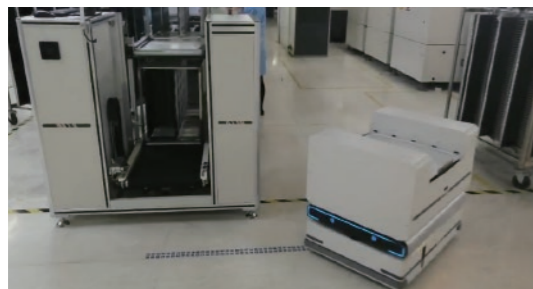

Semiconductor and electronic information manufacturing

Internal logistics intelligent project of famous monitor manufacturing enterprises
Precise and efficient delivery of empty and full Marg box in the process of PCB production

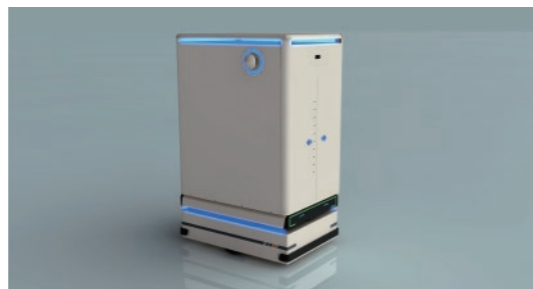

Intelligent logistics upgrade of dust-free plants in semiconductor company

According to the use of materials during production, the dedicated AMR on SMT production lines, enables the unmanned delivery of multi-disk materials from automatic storehouse to production lines, saving preparation time and avoiding the loss of mistake and leakage of materials.

Power Transmission Products Manufacturing



The construction project of intelligent electrical equipment in green digital production base

The flexible transfer of multi-shape, multi-weight materials, between all stereoscopic warehouses and storage area in 50,000m2 plant area, and docking the third-party equipments, such as the on-site state of wharfs, RGV robots, the switch of virtual truss door and inspection conveyors. The dispatch and general control of multi-vehicle and multi-equipment, accomplishes digitization of the logistics of the whole factory.



The digitalize factory projects of intelligent manufacturing in electrical equipment industry

The omni-directional heavy load AMR and intelligent unmanned forklifts of IPLUS dock the third-party equipments, such as stereoscopic storehouses, elevators, production lines, enabling the flexible transfer of different materials, such as electromagnetic wires, moulds, coils, between different processes.

Automobile Industry



Whole Vehicle Manufacturing

Automobile assembly factories use AGV to replace human labor and tow trucks



Automobile Component Manufacturing

The waiting time of pumps manufacturing was reduced from 2 hours to 7 minutes with 99.99% accuracy and 100% safe delivery rate.

Healthcare Industry



Pharmaceutical Packaging Industry

Flexible transfer of process material in mixing, pre-forming, vulcanization and edge removing.



Medical Appliance Manufacturing

Autonomous robots to realize flexible transfer of components in multiple production lines.

▶▶ New energy and photovoltaic industry



Manufacturing logistics transition upgrade projects of famous photovoltaic battery piece production enterprises. The customized precise dual-row, dual-layer belt conveyor, can accomplish the fetching, delivery of wafer box accurately and efficiently, and synchronous logistics docking and placing on the scale of ±2mm.



Logistics automation and flexible delivery in PCB intelligent plant. Various materials can be transported on site.

▶▶ Textiles and Garment Industry



Inter-Line/Inter-Port auto transportation for Industrial-leading sock manufacturing factory enabling material traceability.



Textile Industry
Load and unload yarn with the help of mobile manipulator in the wire twisting and reeling processes.

▶▶ Instrument Industry

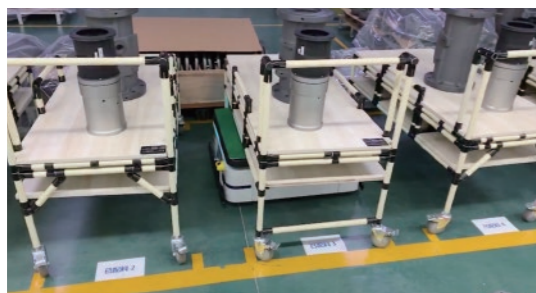

AGV is used to transport products such as transmitters/actuators/metal tester machines from its production line to warehouses.

▶▶ Ports, Industrial Parks and Airports



Autonomous flexible transfer of containers, packages, luggage and parking using autonomous mobile robots

■ Full Lifecycle Services

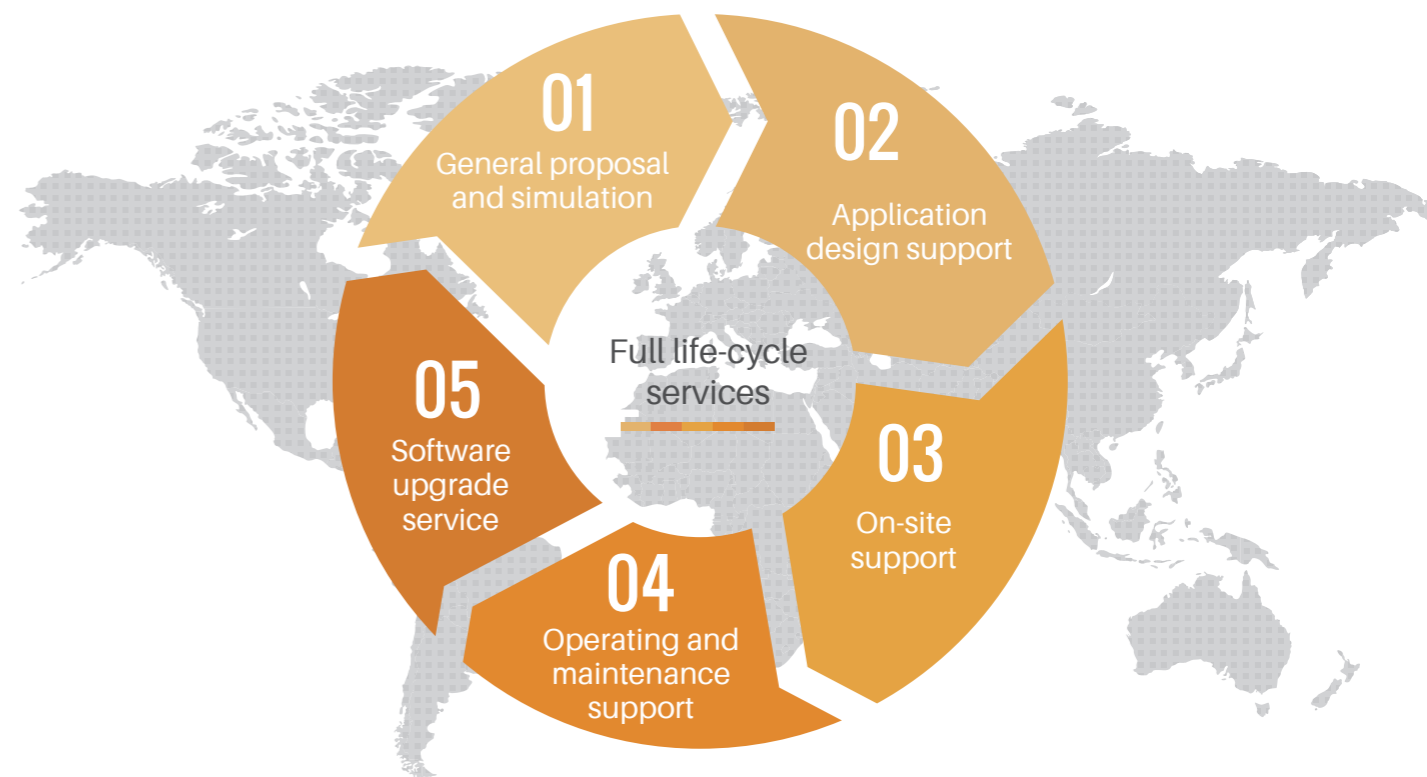

National service hotline
+86 156 1843 1381

IPLUS MOBOT offers localization services nation-wide, covering the whole lifecycle from overall solutions design to on-site deployment and testing, operation maintenance and system upgrade support.

Quick service response

Comprehensive pre-sale application proposal, sales, after-sales services

Top-notch product quality assurance system

Quick and professional deployment

On-site support and maintenance services

Professional technical support

Specifications



Basic Parameters			
Navigation	Laser+Camera+IMU	Laser+Camera+IMU	Laser+Camera+IMU
Maximum Payload	400kg	600kg	1000kg
Dimension (L*W*H)	841*540*286mm	984*782*304mm	984*782*304mm
Weight	150kg	220kg	220kg
Laser	Single laser	Double laser	Double laser
Laser FoV	210°	360°	360°
Bottom Camera	Standard	Standard	Standard
Top Camera	Optional	Optional	Optional
Touch Screen	7-inch	7-inch	7-inch
Performance			
Position Accuracy	±10mm/1°	±10mm/1°	±10mm/1°
Stop Accuracy	±2mm/0.2°	±2mm/0.5°	±2mm/0.5°
Max. Speed	1.5m/s	1.5m/s	1.2m/s
Main Drive Mode	Forward (Bidirectional)	Bidirectional	Bidirectional
Battery			
Capacity	LFP 48V 31.5Ah	LFP 48V 60Ah	LFP 48V 60Ah
Charging Time	2h	3h	3h
Operating Time	≥8h	≥8h	≥8h
Charging Cycles	Automatic/Manual	Automatic/Manual	Automatic/Manual
Safety Configuration			
Laser Obstacle Avoidance	Standard	Standard	Standard
Laser Obstacle Stoppage	Standard	Standard	Standard
Light and Audio	Standard	Standard	Standard
Bumper	Standard	Standard	Standard
Emergency Stop	Standard	Standard	Standard
Environment			
Indoor/Outdoor	Indoor	Indoor	Indoor
Maximum Map Size	≥1000000m ²	≥1000000m ²	≥1000000m ²
Maximum slope	5%	5%	5%
Ambient temperature	0~40°C	0~40°C	0~40°C
Humidity	10%~90% non-condensing	10%~90% non-condensing	10%~90% non-condensing
Communication	IEEE 802.11 a/b/g/n/ac	IEEE 802.11 a/b/g/n/ac	IEEE 802.11 a/b/g/n/ac

Drawing

EMMA400L Dimension

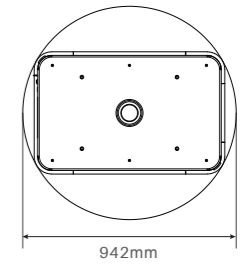
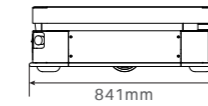
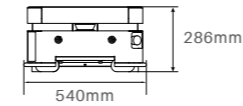

EMMA600 Dimension

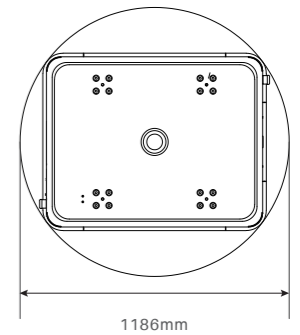
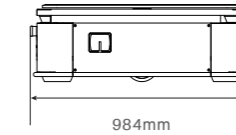
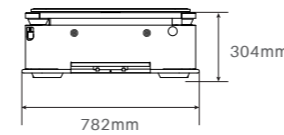

EMMA1000 Dimension

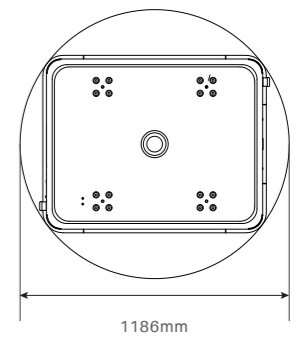
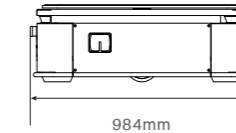
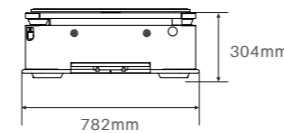

■ MEMO