

Plug PowerTOP® Xtra - Part no. 13106

- screw terminals
- rubberised grip area
- frame terminals
- highly heat resistant contact carrier
- nickel plated contacts
- cable gland and sealing
- strain relief and protection against kinking
- enclosure with thread lock
- two safety slides

Technical information	
Ampere	63 A
Poles	4 p
Voltage	400V
Earth position	6 h
Hertz	50-60 Hz
Connection technology	Screw terminals
Contact	nickel plated contacts, highly heat resistant contact carrier
Protection type	IP 44

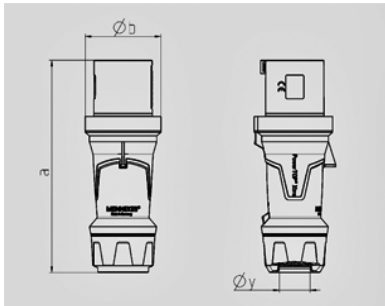

Drawing 2 MB 226	Amp. Poles	63		
		3	4	5
Dim. in mm	a	250	250	250
	b	90	90	90
	y	36	36	36
Terminal for cond. cross		6	6	6
section (mm ²) min.-max.		-16	-16	-16