

Plug PowerTOP® Xtra - Part no. 13225

- screw terminals
- rubberised grip area
- frame terminals
- highly heat resistant contact carrier
- nickel plated contacts
- cable gland and sealing
- strain relief and protection against kinking
- enclosure with thread lock
- two safety slides

Protection type	IP 67
Ampere	125 A
Poles	5p
Voltage	400
Hertz	50-60Hz
Earth position	6h
Contact	nickel plated contacts, highly heat resistant contact carrier
Connection technology	Screw terminals

Std. Pack. 5 Qty.

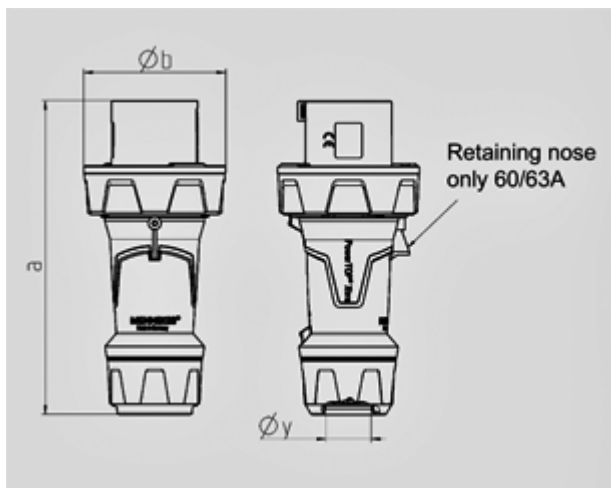

Drawing	Amp.	63			125		
		3	4	5	3	4	5
2 MB 225	Poles						
Dim. in mm	a	250	250	250	290	290	290
	b	114	114	114	130	130	130
	y	36	36	36	49	49	49
Terminal for cond. cross		6	6	6	25	25	25
section (mm ²) min.-max.		-16	-16	-16	-50	-50	-50