



order number : 143

## Receptacle

Products with pilot contacts: order number+index P, e. g. 143 P.

Internal Fixing

Cable entry: one from top and one (for cut out) from bottom

125A5P 6H400V wall mounted receptacle

IP67

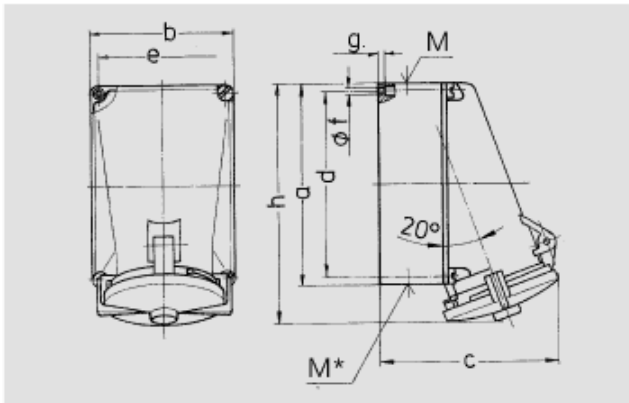

1 MB 162	Amp.	125	
1 MB 163	Pole	4	5
Maße in mm	a	264	264
	b	163	163
	c	203	203
	d	240	240
	e	140	140
	f	8,1	8,1
	g	8	8
	h	313	313
	M	50	50
	M*	50	50
Leitung bis mm Ø		38	38
Klemmen für Leiterquerschnitt von bis mm <sup>2</sup>		—25	—25
		—35	—35

Article-group : 1050

voltages : 400V

rated current : 125A

pole : 5 pole

IP protection types : IP67

position of ground contact : 6h

packing unit : 0003







pilot contact (63A-125A) : without pilot-contact

contact carriers : standard

contact technique : screw contact

weight : 2020 g

**PART NUMBERS**

V	110V	230V	400V	500V	> 50-500V	
Hz	50,60	50,60	50,60	50,60	100-300	300-500
colour						
amp.						
125 A	4	137	138	139	140	
	5	141	142	143	2139	