

Part no. : 252

**Plug AM-TOP**

with screw terminal and monobloc enclosure

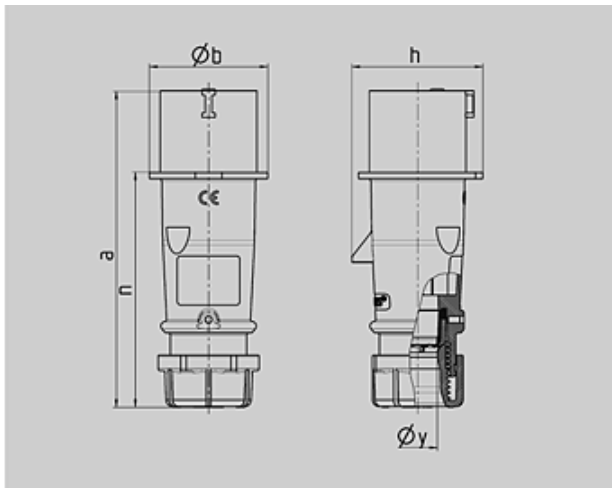

Drawing	Amp.	16			32		
		Poles			3	4	5
<b>2 MB 217</b>							
Dim. in mm	a	142	147	147	186	186	180
	b	53	59	67	70	70	77
	h	59	69,4	76	81	81	89,5
	n	105,2	110,5	110,5	141	141	135
	y	14,5	16	16	22	22	22
Terminal for cond. cross section (mm <sup>2</sup> ) min.-max.		1	1	1	2,5	2,5	2,5
		-2,5	-2,5	-2,5	-6	-6	-6

 Article-group : **2141**

voltages : 400V

rated current : 16A

pole : 4 pole







IP protection types : IP44

position of ground contact : 6h

packing unit : 0010

weight : 146 g

**PART NUMBERS**

	V	<b>110V</b>	<b>230V</b>	<b>400V</b>	<b>500V</b>	<b>&gt;50-500V</b>		
		Hz	50,60	50,60	50,60	50,60	100-300	300-500
colour	amp.							
	<b>16 A</b>	3	247	248	249		2168	2271
		4	250	251	252	253	254	255
	5	256	257	3	2014	2189	2243	
<b>32 A</b>	3	259	260	261		2195	2341	
	4	262	263	264	265	266	267	
	5	268	269	4	2015	2244	2178	