

Part no. : 260

Plug AM-TOP

with screw terminal and monobloc enclosure

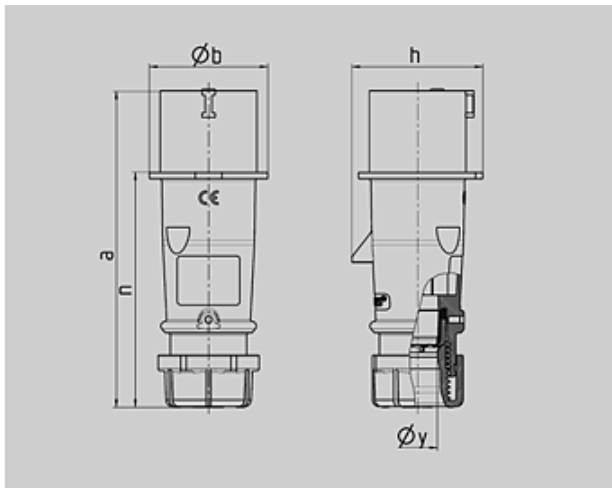

| Drawing | Amp. | 16 | | | 32 | | |
|---|------|-------|-------|-------|-----|-----|------|
| | | Poles | | | 3 | 4 | 5 |
| 2 MB 217 | | | | | | | |
| Dim. in mm | a | 142 | 147 | 147 | 186 | 186 | 180 |
| | b | 53 | 59 | 67 | 70 | 70 | 77 |
| | h | 59 | 69,4 | 76 | 81 | 81 | 89,5 |
| | n | 105,2 | 110,5 | 110,5 | 141 | 141 | 135 |
| | y | 14,5 | 16 | 16 | 22 | 22 | 22 |
| Terminal for cond. cross section (mm ²) min.-max. | | 1 | 1 | 1 | 2,5 | 2,5 | 2,5 |
| | | -2,5 | -2,5 | -2,5 | -6 | -6 | -6 |

 Article-group : **2141**

voltages : 230V

rated current : 32A

pole : 3 pole







IP protection types : IP44

position of ground contact : 6h

packing unit : 0010

weight : 208 g

PART NUMBERS

| | V | 110V | 230V | 400V | 500V | >50-500V | |
|-------------|--------|---|---|---|---|---|---|
| | Hz | 50,60 | 50,60 | 50,60 | 50,60 | 100-300 | 300-500 |
| | colour |  |  |  |  |  |  |
| | amp. | | | | | | |
| 16 A | 3 | 247 | 248 | 249 | | 2168 | 2271 |
| | 4 | 250 | 251 | 252 | 253 | 254 | 255 |
| | 5 | 256 | 257 | 3 | 2014 | 2189 | 2243 |
| 32 A | 3 | 259 | 260 | 261 | | 2195 | 2341 |
| | 4 | 262 | 263 | 264 | 265 | 266 | 267 |
| | 5 | 268 | 269 | 4 | 2015 | 2244 | 2178 |