

Part no. : 264

Plug AM-TOP

with screw terminal and monobloc enclosure

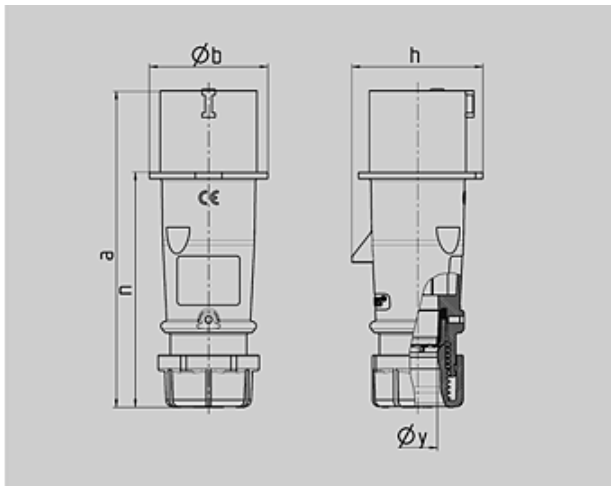

Drawing	Amp.	16			32		
		Poles			3	4	5
2 MB 217							
Dim. in mm	a	142	147	147	186	186	180
	b	53	59	67	70	70	77
	h	59	69,4	76	81	81	89,5
	n	105,2	110,5	110,5	141	141	135
	y	14,5	16	16	22	22	22
Terminal for cond. cross section (mm ²) min.-max.		1	1	1	2,5	2,5	2,5
		-2,5	-2,5	-2,5	-6	-6	-6

 Article-group : **2141**

voltages : 400V

rated current : 32A

pole : 4 pole







IP protection types : IP44

position of ground contact : 6h

packing unit : 0010

weight : 222 g

PART NUMBERS

	V	110V	230V	400V	500V	>50-500V	
		50,60	50,60	50,60	50,60	100-300	300-500
	Hz						
	colour						
	amp.						
16 A	3	247	248	249		2168	2271
	4	250	251	252	253	254	255
	5	256	257	3	2014	2189	2243
32 A	3	259	260	261		2195	2341
	4	262	263	264	265	266	267
	5	268	269	4	2015	2244	2178