

Part no. : 278

Plug AM-TOP

with screw terminal and monobloc enclosure

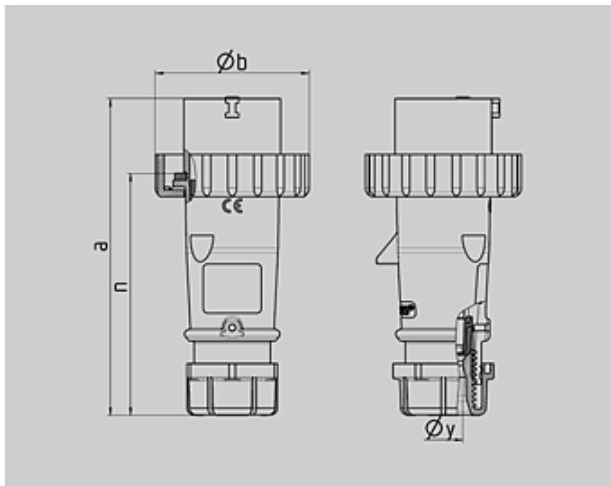

Drawing	Amp.	16			32		
		Poles			Poles		
2 MB 218		3	4	5	3	4	5
Dim. in mm	a	142	144	147	186	186	180
	b	70	78	87	94	94	101
	n	109	111	114	145	145	138
	y	14,5	16	16	22	22	22
Terminal for cond. cross section (mm ²) min.-max.		1	1	1	2,5	2,5	2,5
		-2,5	-2,5	-2,5	-6	-6	-6

 Article-group : **2149**

voltages : 230V

rated current : 16A

pole : 3 pole







IP protection types : IP67

position of ground contact : 6h

packing unit : 0010

weight : 133 g

PART NUMBERS

	V	110V	230V	400V	500V	>50-500V	
	Hz	50,60	50,60	50,60	50,60	100-300	300-500
	colour						
	amp.						
16 A	3	277	278	279			
	4	280	281	282	283	284	285
	5	286	287	288			
32 A	3	289	290	291			
	4	292	293	294	295	296	297
	5	298	299	300			