

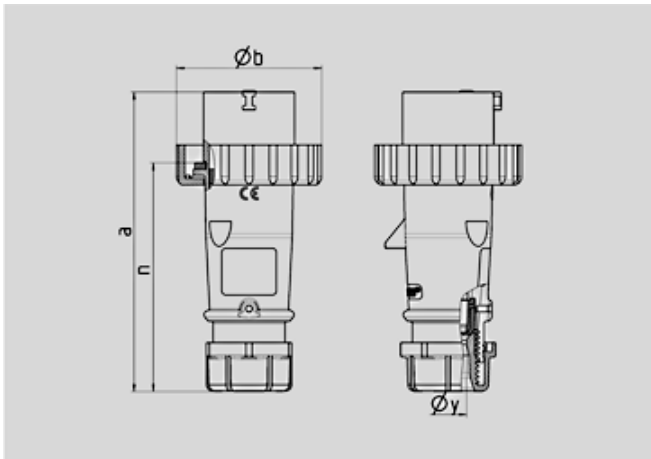

order number : 294







Plug AM-TOP

 with screw terminal and monobloc enclosure
 32A4P 6H400V plug AM-TOP IP67

Zeichnung 2 MB 218	Amp. Pole	16			32		
		3	4	5	3	4	5
Maße in mm	a	142	144	147	186	186	180
	b	70	78	87	94	94	101
	n	109	111	114	145	145	138
	y	14,5	16	16	22	22	22
Leiterquerschnitt von bis mm²		1	1	1	2,5	2,5	2,5
		-2,5	-2,5	-2,5	-6	-6	-6

Article-group :	2149
voltages :	400V
rated current :	32A
pole :	4 pole
IP protection types :	IP67
position of ground contact :	6h
packing unit :	0010
contact carriers :	standard
contact technique :	screw contact
weight :	313 g

PART NUMBERS

	V	110V	230V	400V	500V	>50-500V	
	Hz	50,60	50,60	50,60	50,60	100-300	300-500
	colour						
	amp.						
16 A	3	277	278	279			
	4	280	281	282	283	284	285
	5	286	287	288			
32 A	3	289	290	291			
	4	292	293	<u>294</u>	295	296	297
	5	298	299	300			