

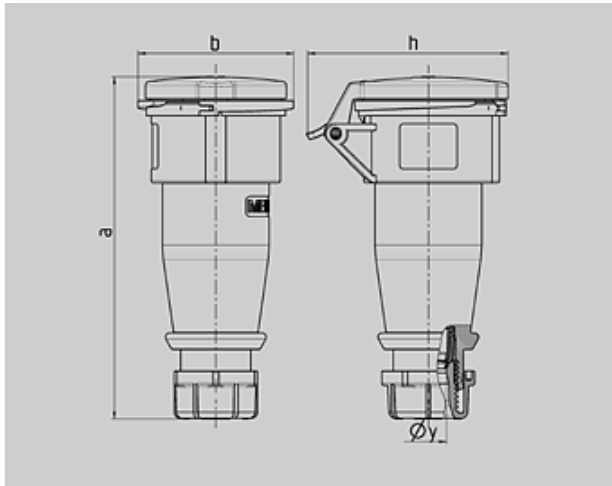

Part no. : 522

Connector AM-TOP

with cable sleeve



Drawing	Amp.	16			32		
		3 MB 63			Poles		
Dim. in mm		3	4	5	3	4	5
		a		162	165	167	209
b		60	68	76	82	82	89
h		83	92	98	100	100	108
y		14,5	16	16	22	22	22
Terminal for cond. cross section (mm ²) min.-max.		1	1	1	2,5	2,5	2,5
		—2,5	—2,5	—2,5	—6	—6	—6

Article-group : 3141

voltages : 230V

rated current : 32A

pole : 3 pole







IP protection types : IP44

position of ground contact : 6h

packing unit : 0010

weight : 247 g

PART NUMBERS

	V	110V	230V	400V	500V	>50-500V	
		Hz	50,60	50,60	50,60	50,60	100-300
amp.	colour						
	16 A	3	509	510	511		2441
4		512	513	514	515	516	517
5		518	519	5	2026	2193	2495
32 A	3	521	522	523		2196	2674
	4	524	525	526	527	528	529
	5	530	531	6	2027	2245	2493