

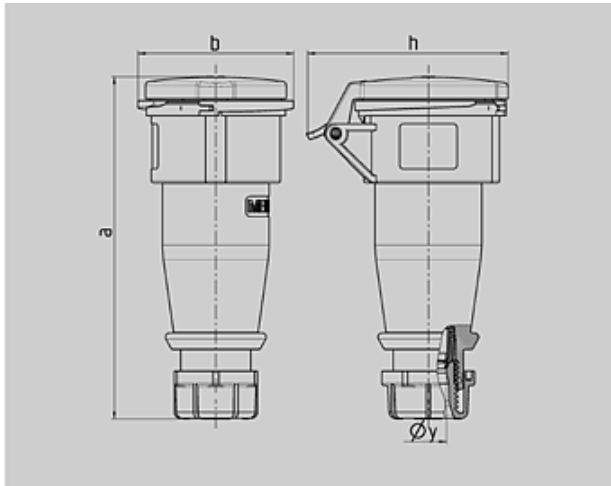

Part no. : 526

Connector AM-TOP







with cable sleeve



Drawing	Amp. Poles	16			32		
		3	4	5	3	4	5
Dim. in mm	a	162	165	167	209	209	208
	b	60	68	76	82	82	89
	h	83	92	98	100	100	108
	y	14,5	16	16	22	22	22
Terminal for cond. cross section (mm²) min.-max.		1 —2,5	1 —2,5	1 —2,5	2,5 —6	2,5 —6	2,5 —6

Article-group : 3141
 voltages : 400V
 rated current : 32A
 pole : 4 pole
 IP protection types : IP44
 position of ground contact : 6h
 packing unit : 0010
 weight : 256 g

PART NUMBERS

	V	110V	230V	400V	500V	>50-500V	
	Hz	50,60	50,60	50,60	50,60	100-300	300-500
	colour						
	amp.						
16 A	3	509	510	511		2441	2517
	4	512	513	514	515	516	517
	5	518	519	5	2026	2193	2495
32 A	3	521	522	523		2196	2674
	4	524	525	526	527	528	529
	5	530	531	6	2027	2245	2493