

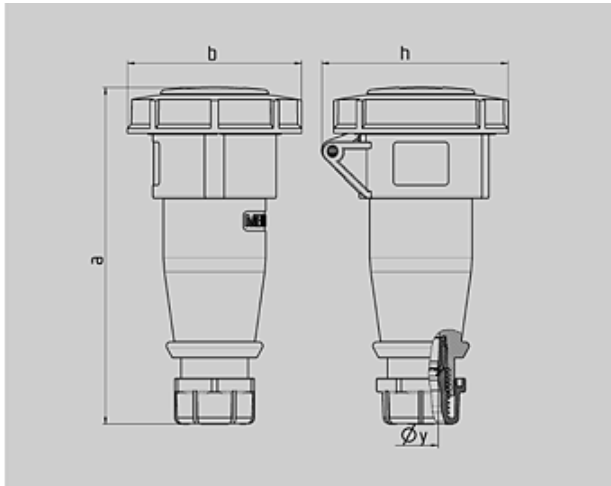

Part no. : 544

**Connector AM-TOP**

with cable gland



Drawing	Amp. Poles	16			32		
		3	4	5	3	4	5
Dim. in mm	a	146	166	172	212	212	213
	b	72	79	89	96	96	102
	h	80	88	95	98	98	105
	y	14,5	16	16	22	22	22
Terminal for cond. cross section (mm²) min.-max.		1	1	1	2,5	2,5	2,5
		—2,5	—2,5	—2,5	—6	—6	—6

Article-group : 3149

voltages : 400V

rated current : 16A

pole : 4 pole







IP protection types : IP67

position of ground contact : 6h

packing unit : 0010

weight : 200 g

**PART NUMBERS**

	V	110V	230V	400V	500V	>50-500V	
	Hz	50,60	50,60	50,60	50,60	100-300	300-500
	colour						
	amp.						
16 A	3	539	540	541			
	4	542	543	<b>544</b>	545	546	547
	5	548	549	550			
32 A	3	551	552	553			
	4	554	555	556	557	558	559
	5	560	561	562			