

Wall mounted socket - Part no. 5608A

- switched
- mechanical DUO-interlock
- sockets can be padlocked

Protection type	IP 67
Ampere	32 A
Poles	5p
Voltage	400
Hertz	50-60Hz
Earth position	6h
Contact	standard
Connection technology	Screw terminals

Std. Pack. 1 Qty.

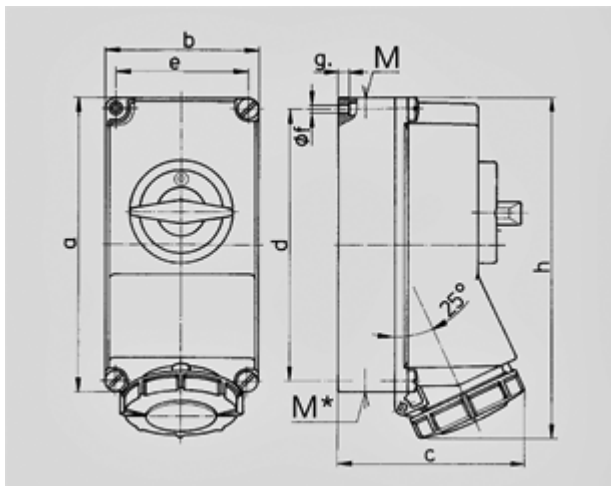

Drawing	Amp.	16			32		
		3	4	5	3	4	5
1 MB 207	Poles						
Dim. in mm	a	225	225	225	225	225	225
	b	118	118	118	118	118	118
	c	144	146	147	152	152	153
	d	208	208	208	208	208	208
	e	101	101	101	101	101	101
	f	6,3	6,3	6,3	6,3	6,3	6,3
	g	8	8	8	8	8	8
	h	252	255	259	268	268	274
	M	1xM25 and 1xM32			1xM25 and 1xM32		
	M*	2x25	2x25	2x25	2x25	2x25	2x25
	Max. cable diam. (mm)	25	25	25	25	25	25
	Terminal for cond. cross section (mm²) min.-max.	1,5	1,5	1,5	2,5	2,5	2,5
		-4	-4	-4	-10	-10	-10