

Wall mounted socket - Part no. 9351

- screw terminals
- highly resistant to chemicals
- with 2 external fixing points
- enclosure base can be turned 180°
- sockets are designed for adding an auxiliary contact switch

Protection type	IP 67
Ampere	32 A
Poles	3p
Voltage	230
Hertz	50-60Hz
Earth position	6h
Contact	standard
Connection technology	Screw terminals

Std. Pack. 5 Qty.

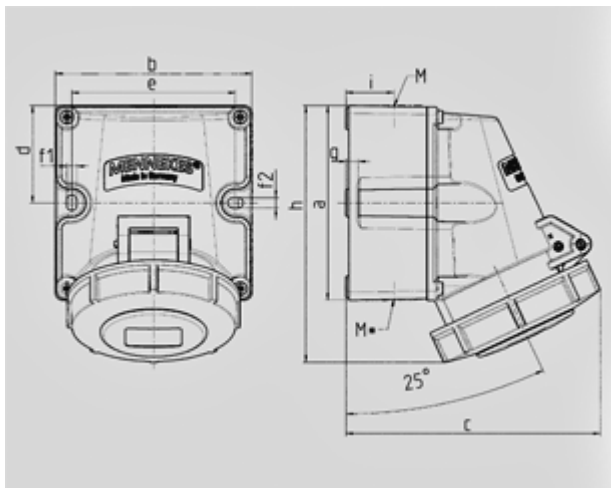

Drawing	Amp.	16			32		
		3	4	5	3	4	5
1 MB 622	Poles						
Dim. in mm	a	100	100	100	100	100	100
	b	101	101	101	109	109	109
	c	117	125	131	157	157	160
	d	50	50	50	50	50	50
	e	84	84	84	92	92	92
	f1	5,3	5,3	5,3	5,3	5,3	5,3
	f2	5,3	5,3	5,3	5,3	5,3	5,3
	g	6,5	6,5	6,5	6,5	6,5	6,5
	h	131	131	132	148	148	148
	i	24,7	24,7	24,7	27,5	27,5	27,5
	M	25 (optional M20)			32 (optional M25)		
	M*	2x25 (blind) to be cut out			2x25 (blind) to be cut out		
	Max. cable diam. (mm)	18 (M25) and 15 (M20)			25 (M32) and 18 (M25)		
	Terminal for cond. cross section (mm²) min.-max.	1,5	1,5	1,5	2,5	2,5	2,5
		-4	-4	-4	-6	-6	-6