



## Main

Range of product	TeSys GV3 TeSys Deca
Range	TeSys Deca TeSys Deca
Device short name	GV3L
Product name	TeSys GV3 TeSys Deca
Product or component type	Motor circuit breaker
Device application	Motor protection
Trip unit technology	Magnetic

## Complementary

Poles description	3P
Network type	AC
Utilisation category	Category A conforming to IEC 60947-2
Network frequency	50/60 Hz
Fixing mode	35 mm symmetrical DIN rail: clipped Panel: screwed (with 3 x M4 screws)
Operating position	Any position
Motor power kW	22 kW at 400/415 V AC 50/60 Hz 30 kW at 500 V AC 50/60 Hz 45 kW at 690 V AC 50/60 Hz
Breaking capacity	100 KA Icu at 230/240 V AC 50/60 Hz 50 KA Icu at 440 V AC 50/60 Hz 12 KA Icu at 500 V AC 50/60 Hz 6 KA Icu at 690 V AC 50/60 Hz 50 kA Icu at 400/415 V AC 50/60 Hz
[Ics] rated service short-circuit breaking capacity	100 % at 230/240 V AC 50/60 Hz 100 % at 400/415 V AC 50/60 Hz 100 % at 440 V AC 50/60 Hz 50 % at 500 V AC 50/60 Hz 50 % at 690 V AC 50/60 Hz
Control type	Rotary handle
[In] rated current	50 A
Magnetic tripping current	700 A
[Ue] rated operational voltage	690 V AC 50/60 Hz conforming to IEC 60947-2
[Ui] rated insulation voltage	690 V AC 50/60 Hz conforming to IEC 60947-2
[Uimp] rated impulse withstand voltage	6 kV conforming to IEC 60947-2
Power dissipation per pole	8 W
Mechanical durability	50000 cycles
Electrical durability	50000 cycles for AC-3 at 415 V
Maximum operating rate	25 cyc/h
Tightening torque	5 N.M on EverLink BTR screw connectors for cable 25 mm <sup>2</sup> 8 N.m on EverLink BTR screw connectors for cable 35 mm <sup>2</sup>
Mechanical robustness	Shocks: 15 Gn for 11 ms closed conforming to IEC 60068-2-27 Shocks: 30 Gn for 11 ms opened conforming to IEC 60068-2-27 Vibrations: 4 Gn, 5...300 Hz conforming to IEC 60068-2-6
Height	132 mm
Width	55 mm

Depth	136 mm
Net weight	0.96 kg
Suitability for isolation	Yes conforming to IEC 60947-1

## Environment

Standards	EN/IEC 60947-2 EN/IEC 60947-4-1 UL 60947-4-1 CSA C22.2 No 60947-4-1
Product certifications	CCC EAC BV LROS (Lloyds register of shipping) DNV-GL ABS UL CSA UKCA
Climatic withstand	Conforming to IACS E10
IP degree of protection	IP20 conforming to IEC 60529
Ambient air temperature for storage	-40...80 °C
Fire resistance	960 °C conforming to IEC 60695-2-11
Operating altitude	3000 m
Ambient air temperature for operation	-20...60 °C

## Packing Units

Unit Type of Package 1	PCE
Package 1 Length	14.5 cm
Number of Units in Package 1	1
Package 2 Width	60 cm
Package 2 Height	75 cm
Package 2 Weight	73.06 kg
Package 1 Width	16 cm
Package 1 Height	6.5 cm
Package 1 Weight	997 g
Number of Units in Package 2	60
Unit Type of Package 2	P06
Package 2 Length	80 cm

## Offer Sustainability

Sustainable offer status	Green Premium product
REACH Regulation	<a href="#">REACH Declaration</a>
EU RoHS Directive	Compliant <a href="#">EU RoHS Declaration</a>
Mercury free	Yes
RoHS exemption information	<a href="#">Yes</a>
China RoHS Regulation	<a href="#">China RoHS Declaration</a>
Environmental Disclosure	<a href="#">Product Environmental Profile</a>
Circularity Profile	<a href="#">End Of Life Information</a>
WEEE	The product must be disposed on European Union markets following specific waste collection and never end up in rubbish bins
California proposition 65	WARNING: This product can expose you to chemicals including: Antimony oxide & Antimony trioxide, which is known to the State of California to cause cancer. For more information go to <a href="http://www.P65Warnings.ca.gov">www.P65Warnings.ca.gov</a>

## Contractual warranty

Warranty	18 months
----------	-----------

Tripping Curves for GV3L Combined with Thermal Overload Relay LRD33

Average Operating time at 20 °C without Prior Current Flow

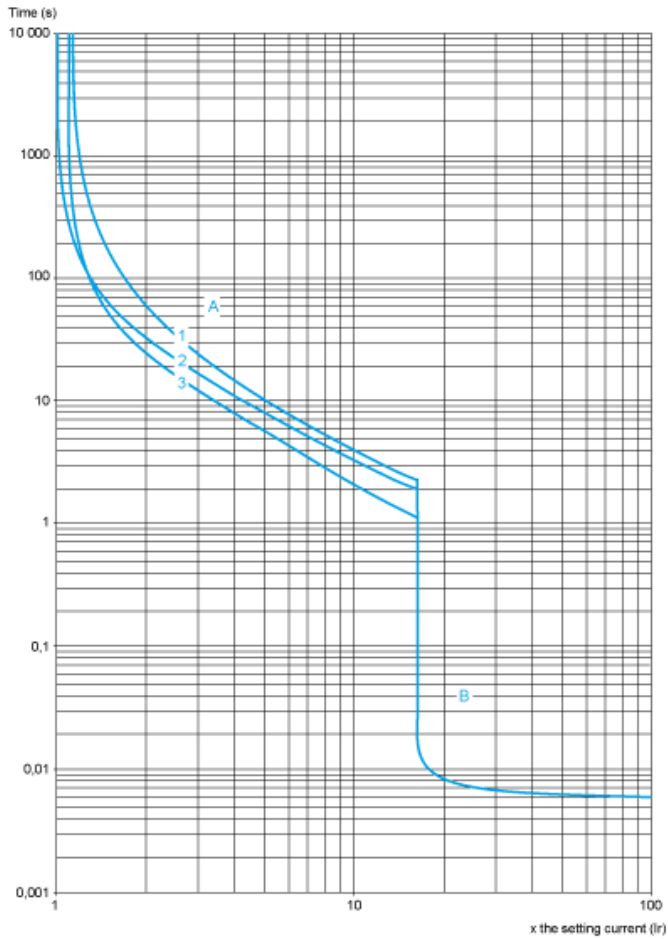

- 1 3 poles from cold state
- 2 2 poles from cold state
- 3 3 poles from hot state
- A Thermal overload relay protection zone
- B GV3L protection zone

Current Limitation on Short-Circuit for GV3L (3-Phase 400/415 V)

Dynamic Stress

$I_{peak} = f(\text{prospective } I_{sc}) \text{ at } 1.05 U_e = 435 \text{ V}$

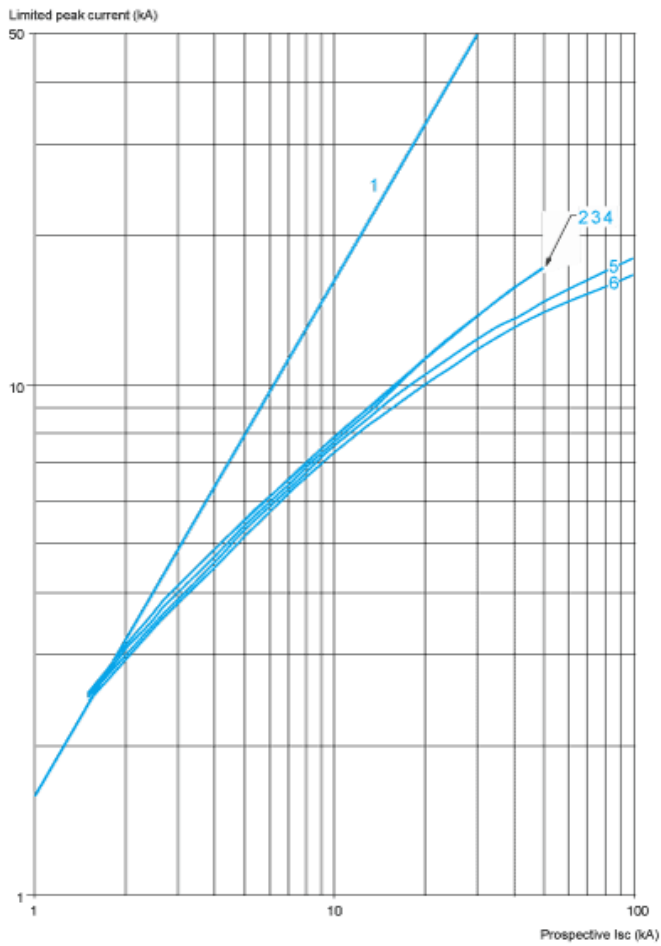

- 1 Maximum peak current
- 2 GV3L80 - GV3L73 - GV3L65
- 3 GV3L50
- 4 GV3L40
- 5 GV3L32
- 6 GV3L25

### Thermal Limit on Short-Circuit for GV3L

Thermal Limit in  $A^2s$

Sum of  $I^2dt = f(\text{prospective Isc})$  at  $1.05 U_e = 435 V$

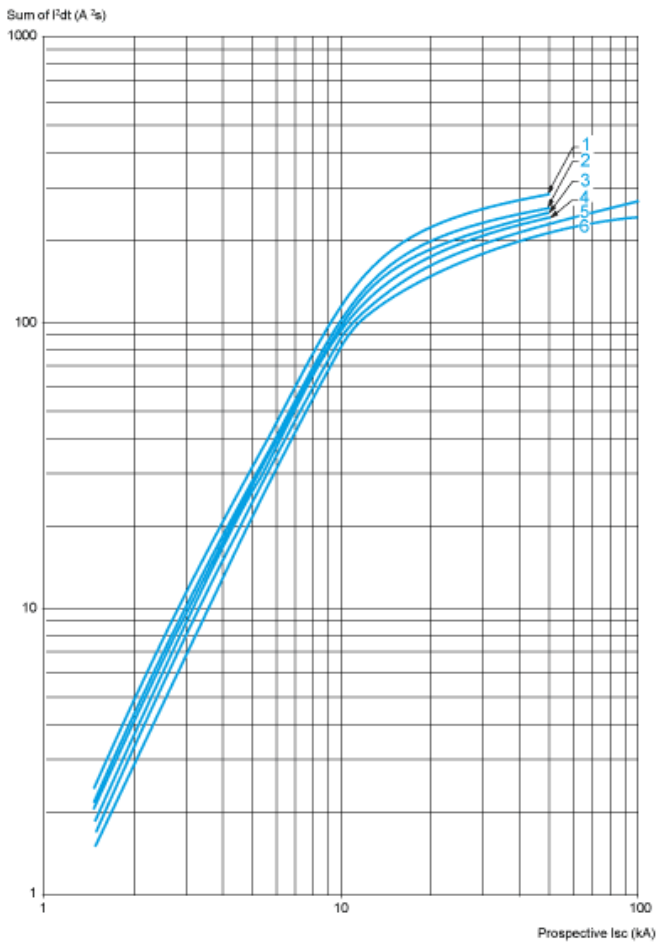

- 1 GV3L73 - GV3L80
- 2 GV3L65
- 3 GV3L50
- 4 GV3L40
- 5 GV3L32
- 6 GV3L25

GV3L, GV3P

Dimensions

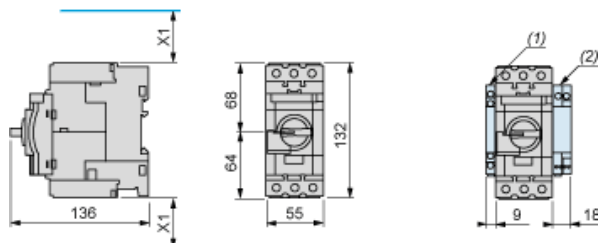

- (1) Blocks GVAN... GVAD... and GVAM11.
- (2) Blocks GV3AU... and GV3AS...

X1 = Electrical clearance (ISC max) 40 mm for  $U_e \leq 500$  V, 50 mm for  $U_e \leq 690$  V

NOTE: Leave a space of 9 mm between 2 circuit breakers: either an empty space or side-mounting add-on contact blocks. Side by side mounting is possible up to 40 °C.

Mounting with Tesys contactor LC1D40A...D80A and relay LR3D313...380 <sup>(1) (2) (3)</sup>

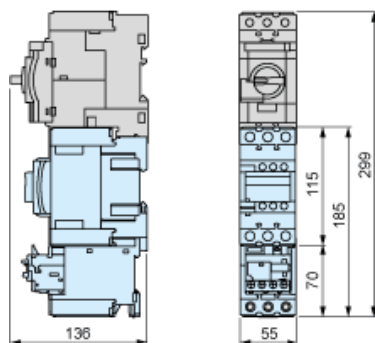

- (1) Mountings with c.b. up to GV3L73, GV3P73.
- (2) For GV3L80, GV3P80 use cable between components for dissipating heat. Consult online datasheets for values.
- (3) S-shape busbar system suitable up to 73 A.

Side by side mounting with Tesys contactor LC1D40A...D73A (S-shape busbar system GV3S<sup>(1)</sup>)

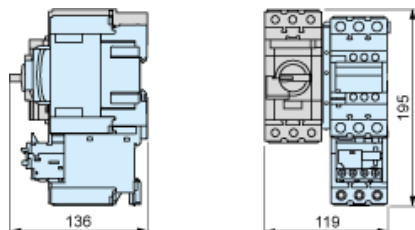

- (1) Mountings with c.b. up to GV3L73, GV3P73.

Mounting on Rail AM1 DE200 or AM1 ED201

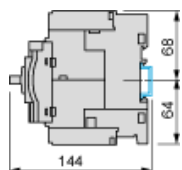

Panel Mounting, using M4 Screws

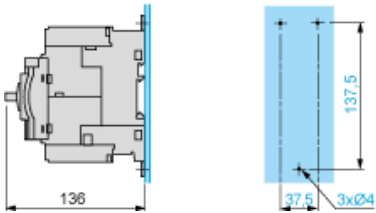

Mounting on Pre-Slotted Plate AM1 PA

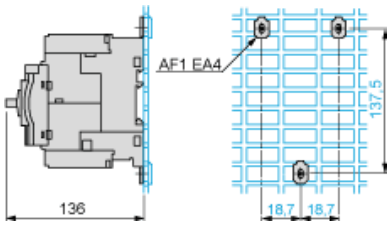

Mounting of External Operator GV3APN01, GV3APN02 or GV3APN04 for Motor Circuit Breakers GV3L

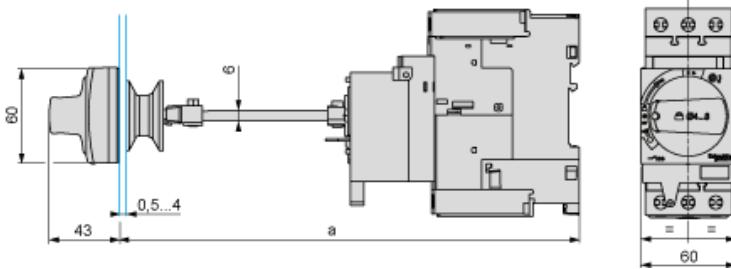

Door cut-out

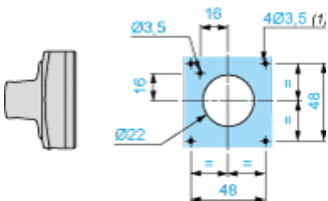

(1) For IP65 only.

Mounting of External Operator GVAPH03 for Motor Circuit Breakers GV3L

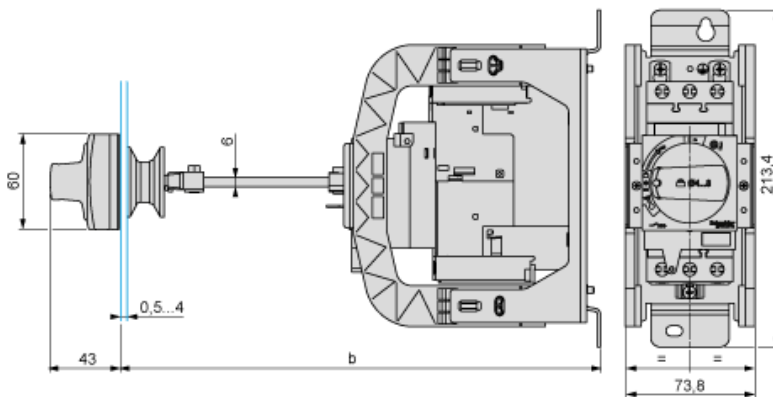

Door cut-out

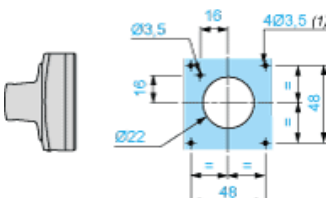

(1) For IP65 only.

	b	
	Minimum	Maximum
GV3APN.. + GVAPH03	200	300
GV3APN.. + GVAPH03 + GVAPK12	300	492

GV3L••

