

















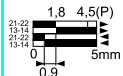
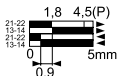
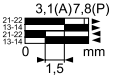
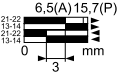
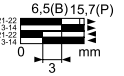

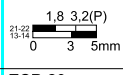
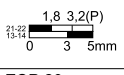
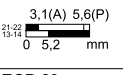
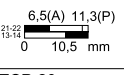
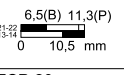
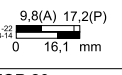

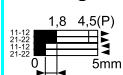
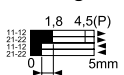

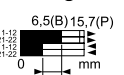
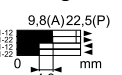

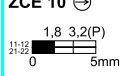
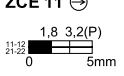
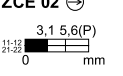
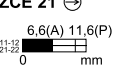
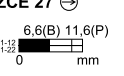
Limit switches

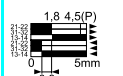
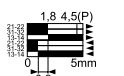
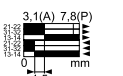
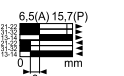
Osiswitch® Universal, Osiconcept®

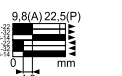
Compact design, plastic, type XCK P

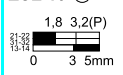
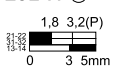
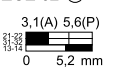
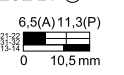
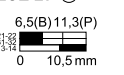
Complete units with 1 ISO M16 x 1.5 cable entry

Type of head	Plunger (fixing by the body)					
	Form B (1)		Form C (1)		Form E (1)	
						
Type of operator	Metal end plunger	Metal end plunger with elastomer boot	Steel roller plunger	Thermoplastic roller lever plunger, horizontal actuation in 1 direction	Thermoplastic roller lever plunger, vertical actuation in 1 direction	Thermoplastic roller lever plunger, horiz. or vert. actuation in 1 direction

References (2) (3)							
	2-pole N/C + N/O snap action (XE2S P2151)	XCK P2110P16 ⊖	XCK P2111P16 ⊖	XCK P2102P16 ⊖	XCK P2121P16 ⊖	XCK P2127P16 ⊖	XCK P2128P16 ⊖
							
	2-pole N/C + N/O break before make, slow break (XE2N P2151)	XCK P2510P16 ⊖	XCK P2511P16 ⊖	XCK P2502P16 ⊖	XCK P2521P16 ⊖	XCK P2527P16 ⊖	XCK P2528P16 ⊖
							
	2-pole N/C + N/C snap action (XE2S P2141)	ZCP 29 + ZCP EP16 + ZCE 10 ⊖	ZCP 29 + ZCP EP16 + ZCE 11 ⊖	ZCP 29 + ZCP EP16 + ZCE 02 ⊖	ZCP 29 + ZCP EP16 + ZCE 21 ⊖	ZCP 29 + ZCP EP16 + ZCE 27 ⊖	ZCP 29 + ZCP EP16 + ZCE 28 ⊖
							
	2-pole N/C + N/C simultaneous, slow break (XE2N P2141)	ZCP 27 + ZCP EP16 + ZCE 10 ⊖	ZCP 27 + ZCP EP16 + ZCE 11 ⊖	ZCP 27 + ZCP EP16 + ZCE 02 ⊖	ZCP 27 + ZCP EP16 + ZCE 21 ⊖	ZCP 27 + ZCP EP16 + ZCE 27 ⊖	ZCP 27 + ZCP EP16 + ZCE 28 ⊖
							
	3-pole N/C + N/C + N/O snap action (XE3S P2141)	ZCP 39 + ZCP EP16 + ZCE 10 ⊖	ZCP 39 + ZCP EP16 + ZCE 11 ⊖	ZCP 39 + ZCP EP16 + ZCE 02 ⊖	ZCP 39 + ZCP EP16 + ZCE 21 ⊖	ZCP 39 + ZCP EP16 + ZCE 27 ⊖	ZCP 39 + ZCP EP16 + ZCE 28 ⊖
							
	3-pole N/C + N/C + N/O break before make, slow break (XE3N P2141)	ZCP 37 + ZCP EP16 + ZCE 10 ⊖	ZCP 37 + ZCP EP16 + ZCE 11 ⊖	ZCP 37 + ZCP EP16 + ZCE 02 ⊖	ZCP 37 + ZCP EP16 + ZCE 21 ⊖	ZCP 37 + ZCP EP16 + ZCE 27 ⊖	ZCP 37 + ZCP EP16 + ZCE 28 ⊖
							
Weight (kg)		0.090	0.090	0.095	0.105	0.100	0.105
Contact operation		 contact closed		(A)(B) = cam displacement		⊖ N/C contact with positive opening operation	
		 contact open		(P) = positive opening point			

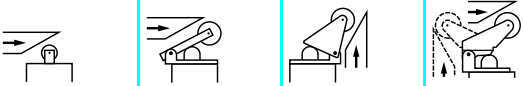
Characteristics						
Switch actuation	On end		By 30° cam			
Type of actuation						
Maximum actuation speed	0.5 m/s		1 m/s			
Mechanical durability (in millions of operating cycles)	15		10		15	
Minimum force or torque	For tripping	15 N	12 N		6 N	
	For positive opening	45 N	36 N		18 N	
Cable entry (3)	1 entry tapped M16 x 1.5 mm for ISO cable gland, clamping capacity 4 to 8 mm					

(1) Form conforming to EN 50047, see page 31900/8.

(2) Switches with gold contacts or ring type connections: please consult our Regional Sales Office.

(3) For an entry tapped for a n° 11 cable gland, replace P16 in the reference by G11. Examples: XCK P2110P16 becomes XCK P2110G11, ZCP EP16 becomes ZCP EG11.

Limit switches

Osiswitch® Universal, Osiconcept®
Compact design, plastic, type XCK P
Complete units with 1 ISO M16 x 1.5 cable entry

Type of head	Plunger (fixing by the head)		Rotary (fixing by the body)				Multi-directional
			Form A (1)				

Type of operator	M18 with metal end plunger	M18 with steel roller plunger	Thermoplastic roller lever	Variable length thermoplastic roller lever	Thermoplastic roller lever, Ø 50 mm	Variable length thermoplastic roller lever, Ø 50 mm	"Cat's whisker" (4)
------------------	----------------------------	-------------------------------	----------------------------	--	-------------------------------------	---	---------------------

References (2)							
	XCK P21H0P16 1.8 4,5(P) 0,9 5mm	XCK P21H2P16 3,1(A)7,8(P) 0 1,5 mm	XCK P2118P16 25° 70°(P) 0 12° 90°	XCK P2145P16 25° 70°(P) 0 12° 90°	XCK P2139P16 25° 70°(P) 0 12° 90°	XCK P2149P16 25° 70°(P) 0 12° 90°	XCK P2106P16 20° 0 15°
	XCK P25H0P16 1,8 3,2(P) 0 3 5mm	XCK P25H2P16 3,1(A) 5,6(P) 0 5,2 mm	XCK P2518P16 25° 70°(P) 0 42° 90°	XCK P2545P16 25° 70°(P) 0 42° 90°	XCK P2539P16 25° 70°(P) 0 42° 90°	XCK P2549P16 25° 70°(P) 0 42° 90°	XCK P2506P16 20° 0 45°
	ZCP 29 + ZCP EP16 + ZCE H0 1,8 4,5(P) 0,9 5mm	ZCP 29 + ZCP EP16 + ZCE H2 3,1(A)7,8(P) 0 1,5 mm	ZCP 29 + ZCP EP16 + ZCE 01 + ZCY 18 25° 70°(P) 0 12° 90°	ZCP 29 + ZCP EP16 + ZCE 01 + ZCY 45 25° 70°(P) 0 12° 90°	ZCP 29 + ZCP EP16 + ZCE 01 + ZCY 39 25° 70°(P) 0 12° 90°	ZCP 29 + ZCP EP16 + ZCE 01 + ZCY 49 25° 70°(P) 0 12° 90°	ZCP29 + ZCP EP16 + ZCE 06 20° 0 15°
	ZCP 27 + ZCP EP16 + ZCE H0 1,8 3,2(P) 0 3 5mm	ZCP 27 + ZCP EP16 + ZCE H2 3,1 5,6(P) 0 5,2 mm	ZCP 27 + ZCP EP16 + ZCE 01 + ZCY 18 25° 70°(P) 0 42° 90°	ZCP 27 + ZCP EP16 + ZCE 01 + ZCY 45 25° 70°(P) 0 42° 90°	ZCP 27 + ZCP EP16 + ZCE 01 + ZCY 39 25° 70°(P) 0 42° 90°	ZCP 27 + ZCP EP16 + ZCE 01 + ZCY 49 25° 70°(P) 0 42° 90°	ZCP 27 + ZCP EP16 + ZCE 06 20° 0
	ZCP 39 + ZCP EP16 + ZCE H0 1,8 4,5(P) 0,9 5mm	ZCP 39 + ZCP EP16 + ZCE H2 3,1(A) 7,8(P) 0 1,5 mm	ZCP 39 + ZCP EP16 + ZCE 01 + ZCY 18 25° 70°(P) 0 12° 90°	ZCP 39 + ZCP EP16 + ZCE 01 + ZCY 45 25° 70°(P) 0 12° 90°	ZCP 39 + ZCP EP16 + ZCE 01 + ZCY 39 25° 70°(P) 0 12° 90°	ZCP 39 + ZCP EP16 + ZCE 01 + ZCY 49 25° 70°(P) 0 12° 90°	ZCP 39 + ZCP EP16 + ZCE 06 20° 0 15°
	ZCP 37 + ZCP EP16 + ZCE H0 1,8 3,2(P) 0 3 5mm	ZCP 37 + ZCP EP16 + ZCE H2 3,1(A) 5,6(P) 0 5,2 mm	ZCP 37 + ZCP EP16 + ZCE 01 + ZCY 18 25° 70°(P) 0 42° 90°	ZCP 37 + ZCP EP16 + ZCE 01 + ZCY 45 25° 70°(P) 0 42° 90°	ZCP 37 + ZCP EP16 + ZCE 01 + ZCY 39 25° 70°(P) 0 42° 90°	ZCP 37 + ZCP EP16 + ZCE 01 + ZCY 49 25° 70°(P) 0 42° 90°	ZCP 37 + ZCP EP16 + ZCE 06 20° 0 45°
Weight (kg)	0.130	0.130	0.135	0.145	0.145	0.155	0.085

Contact operation contact closed (A) = cam displacement contact open (P) = positive opening point N/C contact with positive opening operation

Characteristics			
Switch actuation	On end	By 30° cam	By any moving part
Type of actuation			
Maximum actuation speed	0.5 m/s	1.5 m/s	1 m/s (any direct.)
Mechanical durability	10 million operating cycles		5 million op. cycles
Minimum force or torque	For tripping 15 N For positive opening 45 N	10 N 36 N	0.1 N.m 0.25 N.m
Cable entry (3)	1 entry tapped M16 x 1.5 mm for ISO cable gland, clamping capacity 4 to 8 mm		

(1) Form conforming to EN 50047, see page 31900/8.
 (2) Switches with gold contacts or ring type connections: please consult our Regional Sales Office.
 (3) For an entry tapped for a n° 11 cable gland, replace P16 in the ref. by G11. Examples: XCK P21H0P16 becomes XCK P21H0G11, ZCP EP16 becomes ZCP EG11.
 (4) Value taken with actuation by moving part at 100 mm from the fixings.

Dimensions

Limit switches

Osiswitch® Universal, Osiconcept®

Compact design, plastic, type XCK P

Complete units with 1 ISO M16 x 1.5 cable entry

ZCP 2● + ZCP EP16 / ZCP 3● + ZCP EP16

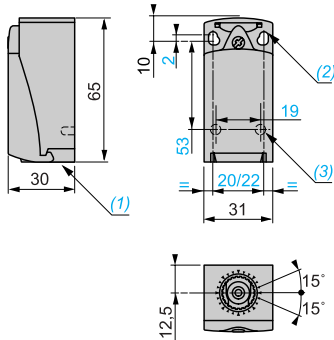

ZCE 10

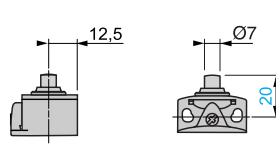

ZCE 11

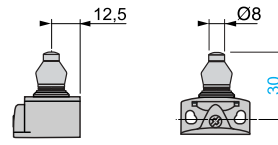

ZCE 02

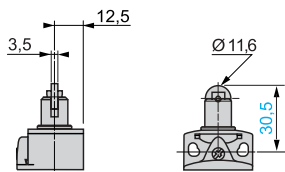

ZCE 21

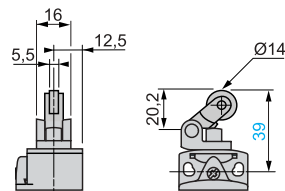

ZCE 27

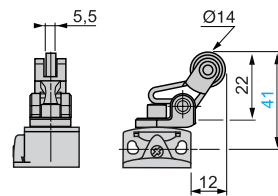

ZCE 28

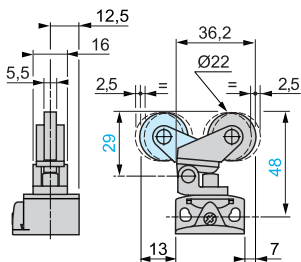

ZCE H0

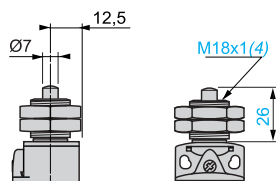

ZCE H2

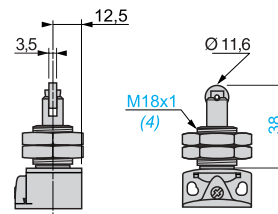

- (1) Tapped entry for ISO M16 x 1.5 or Pg 11 cable gland.
 (2) 2 elongated holes $\text{Ø} 4.3 \times 6.3$ mm on 22 mm centres, 2 holes $\text{Ø} 4.3$ on 20 mm centres.
 (3) 2 x $\text{Ø} 3$ holes for support studs, depth 4 mm.
 (4) Fixing nut thickness 3.5 mm.

Limit switches

Osiswitch® Universal, Osiconcept®

Compact design, plastic, type XCK P

Complete units with 1 ISO M16 x 1.5 cable entry

ZCE 01 + ZCY 18

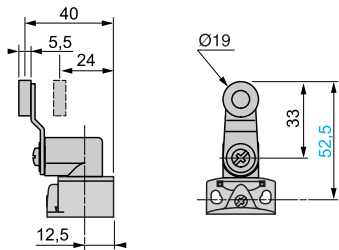

ZCE 01 + ZCY 45

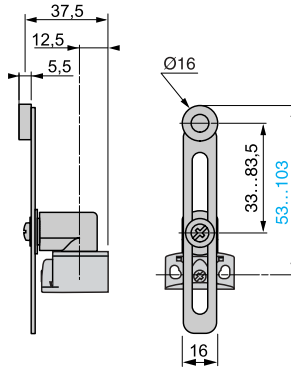

ZCE 01 + ZCY 39

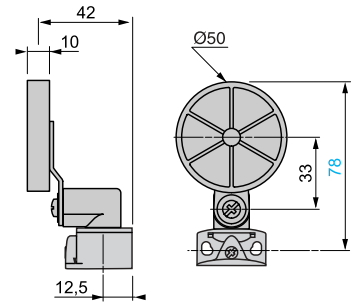

ZCE 01 + ZCY 49

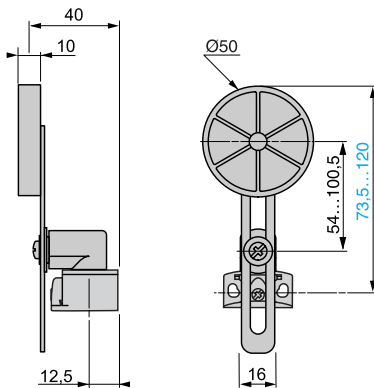

ZCE 06

